



FAÇADES. CLADDING IDEAS.

HAYER & BOECKER



DIE DRAHTWEBER

WEAVING IDEAS.



Architectural Wire Cloth for

- Façade construction
- Protection from falling
- Car Park Façades
- Sound Absorption and Sun Protection

Haver & Boecker began producing woven wire cloth in Hohenlimburg, Germany in 1887. Today, we are one of the world's leading wire weaving companies with a global network of branches and manufacturing facilities. Our work is based upon experience,

continuous research and development of products and manufacturing processes, along with the knowledge and ability of our employees. This combination of tradition and innovation allows us to meet and exceed the high expectations of our customers.

We offer architects and designers a broad range of wire cloth specifications for the exterior design of façades combining high aesthetic value and technical qualities for new buildings or renovation projects.

Building façades can be completely transformed by the aesthetic and technical features of woven wire cloth. Woven wire cloth can enhance a building and give it immense individual character. Depending on the viewing angle and the surrounding light, the material can take on many appearances, from translucent to opaque and discreet. Light and shadow, sun and clouds reflecting on the woven wire cloth surface, create a shimmering second "skin". The correct façade specification and design can fulfil specific criteria such as security, sun protection or sound absorption.

The preferred material is high quality Stainless Steel with molybdenum offering good corrosion resistance. Haver & Boecker has vast experience in the application and development of many effective mounting solutions offering tailor-made fixing solutions and guaranteeing optimum security.

**Challenge:**

Together we identify the specific project requirements in terms of form, shape and function.

**Development:**

Our team of specialists addresses construction and detail requirements and submits initial solutions.

**Detail planning:**

With our experience and knowledge all aspects of the project are brought together.

**Production:**

Precision workmanship using state-of-the-art technology and machinery from start to finish.

**Installation:**

Qualified logistic partners and installation teams guarantee perfect and on-time installation of Haver & Boecker Architectural Wire Cloth.

**After Sales Service:**

Cooperation does not end with the completion of a project; it extends into the future with continued support and advice.

STEP BY STEP TOWARDS YOUR SUCCESS.

Haver & Boecker's process chain provides maximum transparency, flexibility and quality to realize your plans. Through every step of the project a diverse group of specialists is there to support you: The interaction of creativity and technology gives your idea its own individuality.

Not only do you have the confidence of continuous professional service, you also have the possibility to explore new aspects of your design in greater depth, giving you the opportunity to bring new ideas into the process at any given point in time.



Architect: Angel Asenjo + Asociados, E-Malaga

Type of weave: DOKA-MONO 1601

Application: Façade Design / Sun Protection



WEAVING INNOVATIVE SOLUTIONS.

EXHIBITION AND CONFERENCE CENTRE, MALAGA (SPAIN)

Like a fish in the waves of an ocean – inspired by this Mediterranean concept, architect Angel Asenjo created the exhibition and congress centre in Malaga. Built over a period of approximately four years, this magnificent building now boasts over 62,000 square metres of exclusive space for exhibitions, conferences, restaurants and other functions.

The eye-catching feature of this building is the vast canopy on the main sea front façade. Over 130 meters in length and 20 meters wide, approximately 400 wire cloth elements of differing formats and geometries cover the surface area.

Haver & Boecker conducted on-site measuring, manufacturing and fabrication, thus guaranteeing that every single element was precisely tailored and tensioned. The delivery to site and the support during the start up of the installation by the Haver & Boecker team secured a smooth and on time installation.

CHALLENGE

- Cladding the complex canopy construction while maintaining the architectural concept “Like a fish in the waves of an ocean”
- Sun protection

SOLUTION

- Manufacture and installation of single trapezoidal elements at the front, top- and underside of the canopy construction using the Haver & Boecker tension profile and clevis screw tensioning system
- Vertical and horizontal installation
- Precisely tailored elements in bespoke sizes



ROMA ADMINISTRATION BUILDING, ROSTOCK (GERMANY)

Haver & Boecker conducted on-site measuring, manufacturing, fabrication and installation of the wire cloth elements.

CHALLENGE

- Cladding to the façade
- Invisible tensioning system

SOLUTION

- Design & development of bespoke fixing and tensioning system



Architect: Ott Architekten, D-Augsburg

Type of weave: EGLA-MONO 4391

Application: Façade Design



CAR PARK EXHIBITION CENTRE VIENNA (AUSTRIA)

Haver & Boecker delivered ready-to-install elements and provided on-site installation assistance.

CHALLENGE

- High open area
- Façade cladding, maintaining the sweeping form of the building
- Mounting giving continuous appearance to the bottom rail

SOLUTION

- Development of a special weave type which achieved the desired open area of apx. 74 %
- Polygonal installation of straight lined elements
- Development of a bespoke fixing for connecting the rods



Architect: Projektteam Messeplanung, A-Vienna

Type of weave: MULTI-BARRETTE 8144

Application: Façade Design



Architect: Murphy/Jahn, USA-Chicago

Type of weave: MULTI-BARRETTE 8101

Application: Façade Design

CAR PARK 3 AIRPORT COLOGNE-BONN (GERMANY)

Haver & Boecker conducted on-site measuring, manufacturing, fabrication and installation of the woven wire cloth elements.

CHALLENGE

- Façade cladding with sufficient open area
- Projecting part of the façade
- Consideration regarding the connection of the projecting stair tower

SOLUTION

- Single length wire cloth elements tensioned over several floors
- Aesthetic cut-outs for the stair tower bracing



Architect: Bendorf und Partner,
D-Wolfsburg

Type of weave: MULTI-BARRETTE 8301

Application: Façade Design



CAR PARK VOLKSWAGEN AG, WOLFSBURG

Haver & Boecker delivered and installed the woven wire cloth elements.

CHALLENGE

- Car Park façade cladding
- Consideration of the semi-circular shape of the building

SOLUTION

- Faceted installation to the curved areas
- Adaptation of the fixing system to the architecture
- Design and manufacture of bespoke fixing solution at intermediate points on the access ramp

DEUTSCHE POST, BONN (GERMANY)

Haver & Boecker conducted on-site measuring, manufacturing, fabrication and installation of the wire cloth elements.

CHALLENGE

- Façade cladding to the lower part of the building
- Consideration of the complex building shape
- Tensioning of single length elements without intermediate fixing
- Interpreting the optical requirements at fixing points

SOLUTION

- Adaptation of the pitch of the cables to suit the architectural conditions
- Development of bespoke fixing detail to meet the architects' requirements
- Each element individually fabricated to follow inclined areas

AGIR A DOM, GRENOBLE (FRANCE)

Haver & Boecker delivered ready-to-install elements.

CHALLENGE

- Creation of the entrance
- Sun and driving rain protection
- Integration of the logo

SOLUTION

- Dense mesh for the arbour
- Application of logo using stencil technology with specialist coating and varnish seal



Architect: Murphy/Jahn, USA-Chicago

Type of weave: MULTI-BARRETTE 8311

Application: Façade Design



Architect: Arcane Architectes, F-Grenoble

Type of weave: EGLA-TWIN 4223

Application: Sun- and Weather Protection



RVI HOSPITAL, NEWCASTLE (GB)

Haver & Boecker delivered ready-to-install elements and fixing brackets and provided on-site installation assistance.

CHALLENGE

- Driving rain protection to the external staircases
- Aesthetically engineered fixing

SOLUTION

- New fixing system



Architect: AMEC Capital Projects,
GB-Warrington

Type of weave: MULTI-BARRETTE 8101

Application: Façade Design



EXHIBITION CENTRE BOLOGNA (ITALY)

Haver & Boecker delivered ready-to-install fabricated elements and provided on-site installation assistance.

CHALLENGE

- Façade panelling of the exhibition hall
- Optical design

SOLUTION

- Tensioning of individual lengths using Haver & Boecker tensioning system



Architect: Studio Cerri Associati Engineering,
I-Milan

Type of weave: EGLA-MONO 4741

Application: Façade Design



Architect: Murphy/Jahn,
USA-Chicago

Type of weave: MULTI-BARRETTE 8122

Application: Façade Design /
Sun Protection

BAYER LEVERKUSEN (GERMANY)

Haver & Boecker manufactured cut-to-size elements ready for fabrication and installation.

CHALLENGE

- External sun protection to the glass façade of the main administration building

SOLUTION

- Creation of special weave type achieving 39 % open area

BAYER LEVERKUSEN (GERMANY)

Haver & Boecker conducted on-site measuring, manufacturing, fabrication and installation of the wire cloth elements.

CHALLENGE

- Internal sun protection to the glass façade of the lobby
- Accommodation of gradual taper of the front elevation

SOLUTION

- Creation of special weave type achieving 33 % open area
- Design of bespoke mounting system to follow taper of front elevation
- Design of bespoke bottom tensioning system



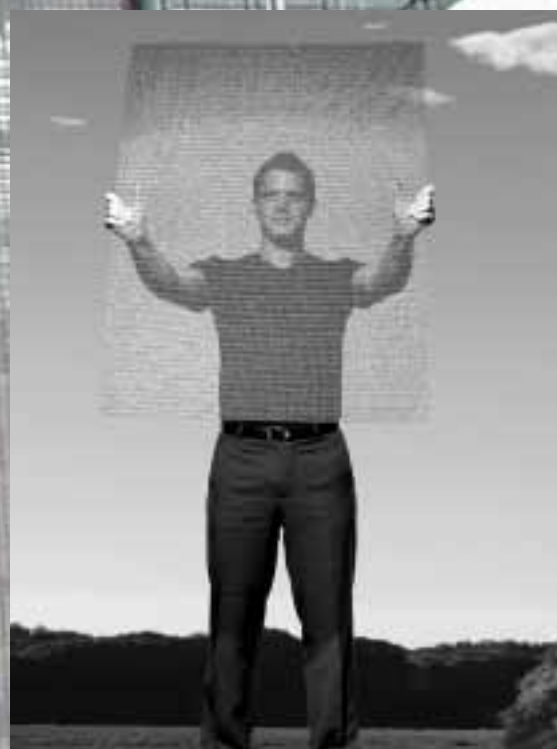
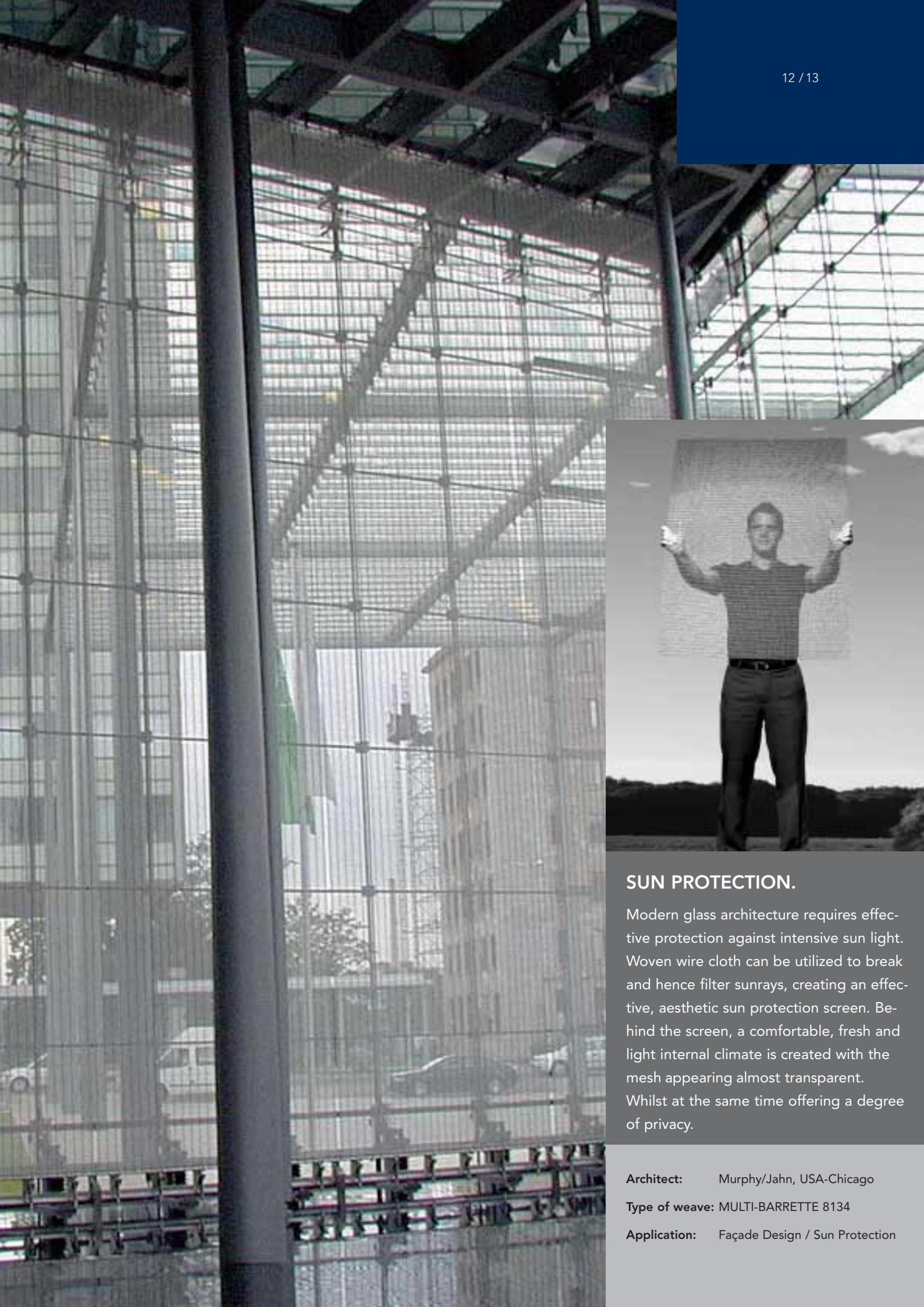

SUN PROTECTION.

Modern glass architecture requires effective protection against intensive sun light. Woven wire cloth can be utilized to break and hence filter sunrays, creating an effective, aesthetic sun protection screen. Behind the screen, a comfortable, fresh and light internal climate is created with the mesh appearing almost transparent. Whilst at the same time offering a degree of privacy.

Architect: Murphy/Jahn, USA-Chicago

Type of weave: MULTI-BARRETTE 8134

Application: Façade Design / Sun Protection



Architect: KPMB, CAN-Toronto
FSA, CAN-Montreal

Type of weave: EGLA-TWIN 4313

Application: Façade Design / Sun Protection



McGILL UNIVERSITY, MONTREAL (CANADA)

Haver & Boecker delivered cut-to-size elements and supported the client during fabrication.

CHALLENGE

- Combination of sun protection and adequate transparency
- Panelling of the cascade shaped façade considering the technical structural demands

SOLUTION

- Development of a special weave type to meet design criteria
- Integration of the Haver & Boecker tensioning system to the frame construction

SOFILO, ST. MALO (FRANCE)

Haver & Boecker delivered cut-to-size elements and supported the client during the fabrication and installation.

CHALLENGE

- Sun protection
- Sliding system

SOLUTION

- Edging of woven wire cloth elements in sliding frames



Architect: Rolinet et Associes, F-Paris

Type of weave: EGLA-TWIN 4243

Application: Façade Design / Sun Protection

MESHES. WAITING FOR YOUR IDEAS.



MULTI-BARRETTE 8301

G^1 (kg/m ²)	A_o^2 (%)
8.0	67



DOGLA-TRIO 1011

G^1 (kg/m ²)	A_o^2 (%)
8.5	66



DOKA-BARRETTE 8914

G^1 (kg/m ²)	A_o^2 (%)
6.5	68

¹⁾ G=Weight, ²⁾ A_o=Open Area

ARCHITECTURAL WIRE CLOTH

Architecture presents itself in many forms. We have developed a wide range of meshes to cover the diverse nature of the applications. The choice of warp and weft wire generates many different patterns each with specific optical features. The use of

different materials and surface treatments can create brilliant, shimmering or even coloured finishes to the mesh.

The following examples are a representative selection of some of our standard weaves on a scale of 1:1.

Of course we do develop individual types of weave, too. Please visit our website at www.weavingideas.com where you will find more information and images of Haver & Boecker Architectural Wire Cloth.

**LARGO-FLEX 2016**

G^1 (kg/m ²)	A_o^2 (%)
7.3	38

**EGLA-MONO 4741**

G^1 (kg/m ²)	A_o^2 (%)
8.7	66

**EGLA-TWIN 4253**

G^1 (kg/m ²)	A_o^2 (%)
6.0	51

**DOKAWELL-MONO 3601**

G^1 (kg/m ²)	A_o^2 (%)
5.3	52

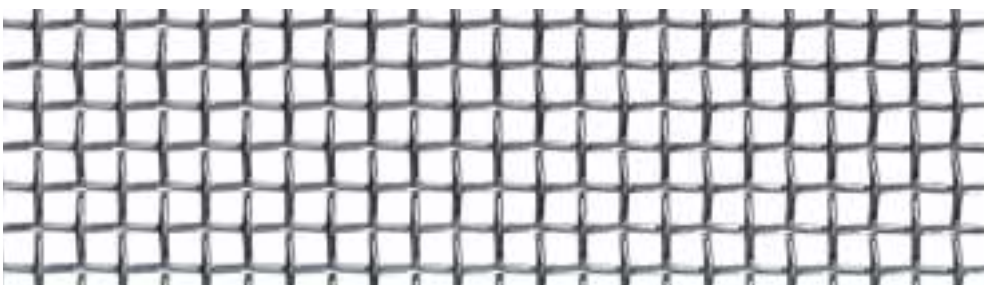
**DOKA-MONO 1601**

G^1 (kg/m ²)	A_o^2 (%)
6.0	51

¹⁾ G=Weight, ²⁾ A_o=Open Area

SOLUTIONS. TECHNOLOGY FOR YOUR IDEAS.



Top fixing:
Tension profile and clevis screw



Intermediate fixing:
Wire connector

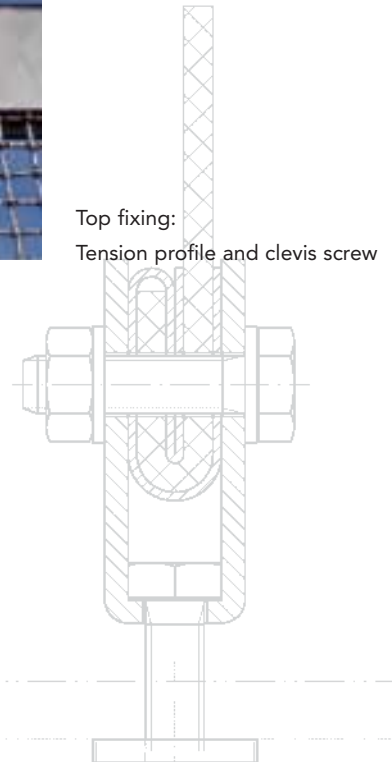

Bottom fixing:
Tension profile, clevis screw
and tension springs

TENSIONING SYSTEMS

We have developed a number of tensioning systems and edging details to ensure technical and optical integration of wire cloth elements with the façade. These offer a

smooth and problem free installation whilst ensuring optimum performance of the structure. These pages show some of the most common methods. Please visit our website at

www.weavingideas.com where you will find further information about Haver & Boecker tensioning systems.

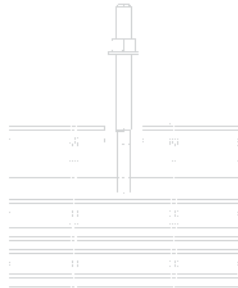

Top fixing:
Round support bar integrated
in triangular bracket
(Type of weave: MULTI-BARRETTE)

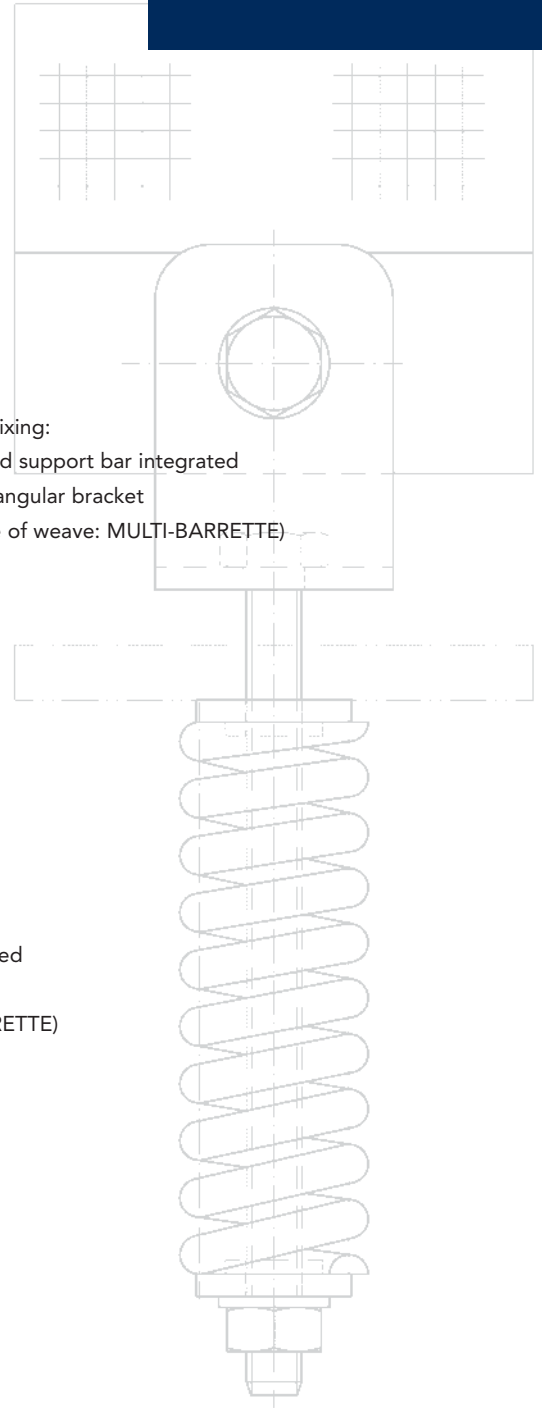

Intermediate fixing:
Round bar with integral
pendular fixing plates attached
to triangular bracket
(Type of weave: MULTI-BARRETTE)



Bottom fixing:
Round bar with eyebolt
(Type of weave: MULTI-BARRETTE)

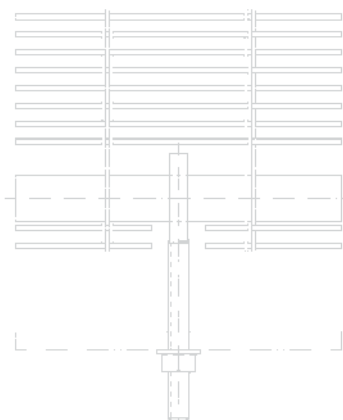

Belgium:**HAYER BELGIUM S.A.**

Rue des Gaillettes 9
 B-4651 BATTICE
 Téléphone: 087-69 29 60
 Fax: 087-69 29 61
 E-Mail: hbsa@cybernet.be

France:**HAYER & BOECKER Toiles Métalliques**

115, rue neuve d'Argenson
 F-24100 BERGERAC
 Téléphone: 5-53 24 93 13
 Fax: 5-53 24 95 99
 E-Mail: haver.toiles@wanadoo.fr

Spain:**HAYER & BOECKER Telas Metalicas**

Avda. Les Bobiles, 7
 Casa 2
 E-08850 GAVA (Barcelona)
 Teléfono: 93-6 62 63 55
 Fax: 93-6 62 90 59
 E-Mail: haverboecker@telefonica.net

Great Britain:**H&B Wire Fabrications Ltd.**

30-32 Tatton Court
 Kingsland Grange, Woolston
 GB-WARRINGTON, Cheshire WA1 4RR
 Phone: 01925-81 95 15
 Fax: 01925-83 17 73
 E-Mail: sales@hbwf.co.uk
 Internet: www.hbwf.co.uk

U.S.A.:**W.S. TYLER – Wire Cloth Products**

8570 Tyler Boulevard
 USA-MENTOR, Ohio 44060
 Phone: 440-974-1047 + 800-321-6188
 Fax: 440-974-0921
 E-Mail: wstyler@wstyler.com
 Internet: www.wstyler.com

Canada:**W.S. TYLER CANADA LTD.**

225 Ontario Street
 CAN-ST. CATHARINES, Ontario L2R 7B6
 Phone: 905-688-2644 + 800-325-5993
 Fax: 905-688-4733
 E-Mail: wstsales@wstyler.on.ca
 Internet: www.wstyler.on.ca

HAYER & BOECKER**DIE DRAHTWEBER**

HAYER & BOECKER
 Ennigerloher Straße 64
 D-59302 OELDE
 Germany

Phone: +49-(0) 25 22-30 684
 Fax: +49-(0) 25 22-30 767
 E-Mail: architektur@haverboecker.com
 Internet: www.weavingideas.com